

- Ап. В6 - 80,82кв.м /101,37/
- Ап. В7 - 107,43кв.м /134,19/
- Ап. В8 - 75,31кв.м /94,54/
- Ап. В9 - 65,40кв.м /82,26/
- Ап. В10 - 55,30кв.м /69,67/
- Ап. В11 - 64,30кв.м /80,74/

**ВХОД \*В\***  
РАЗПРЕДЕЛЕНИЕ ТРЕТИ ЕТАЖ

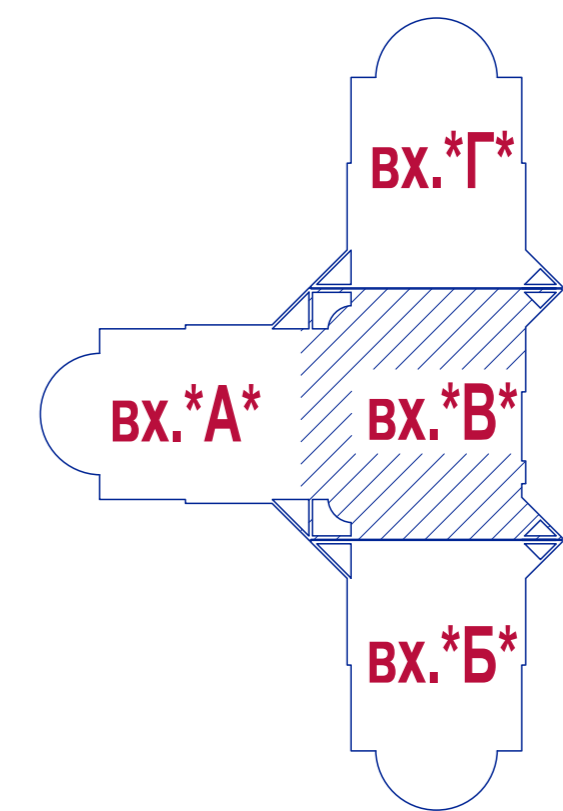
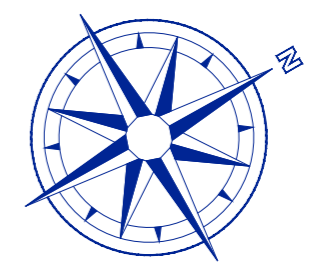
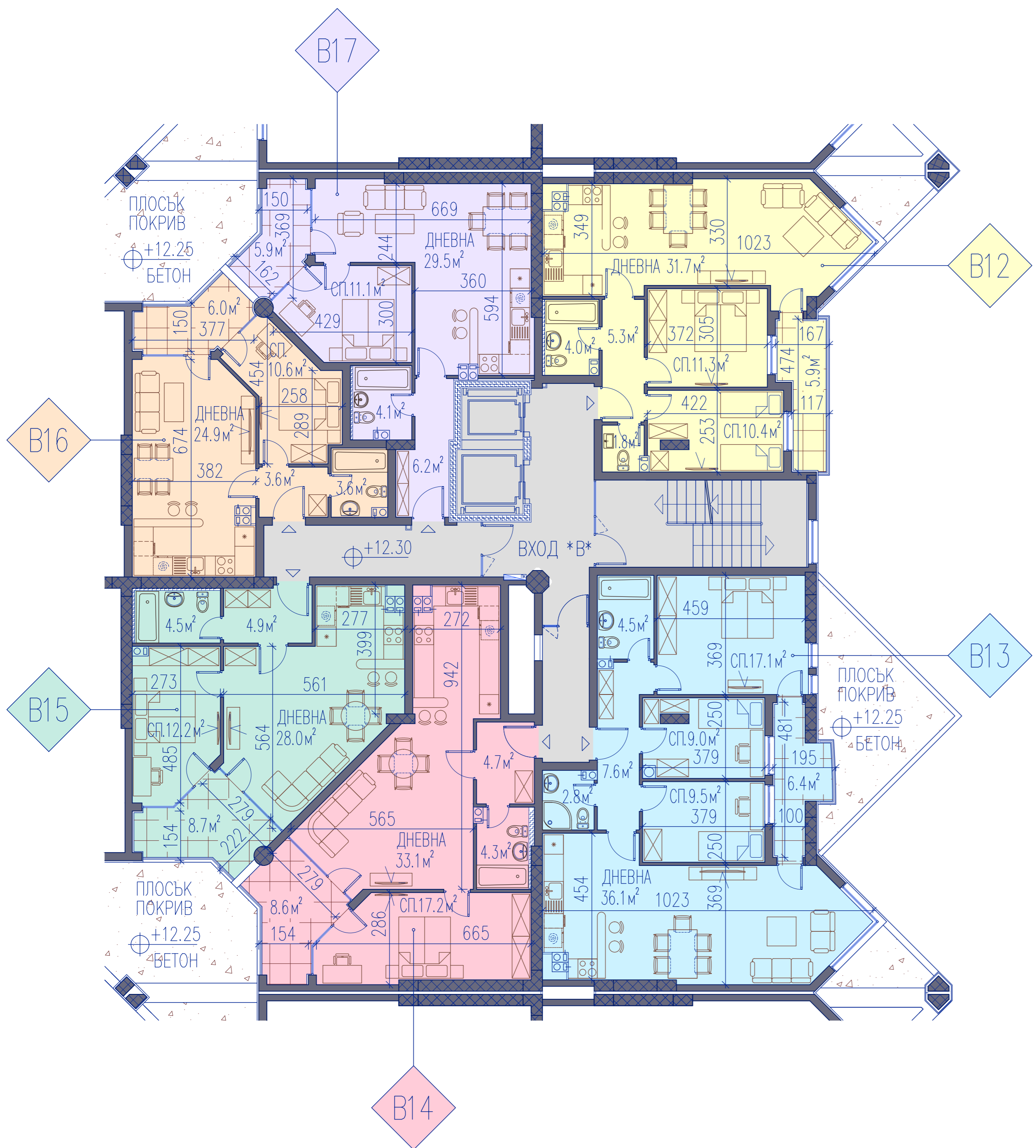

- Ап. В12 - 80,82кв.м /101,33/**
- Ап. В13 - 106,75кв.м /133,32/**
- Ап. В14 - 75,50кв.м /94,74/**
- Ап. В15 - 65,22кв.м /82,04/**
- Ап. В16 - 54,81кв.м /69,07/**
- Ап. В17 - 64,15кв.м /80,56/**

**ВХОД \*В\***  
**РАЗПРЕДЕЛЕНИЕ ЧЕТВЪРТИ ЕТАЖ**

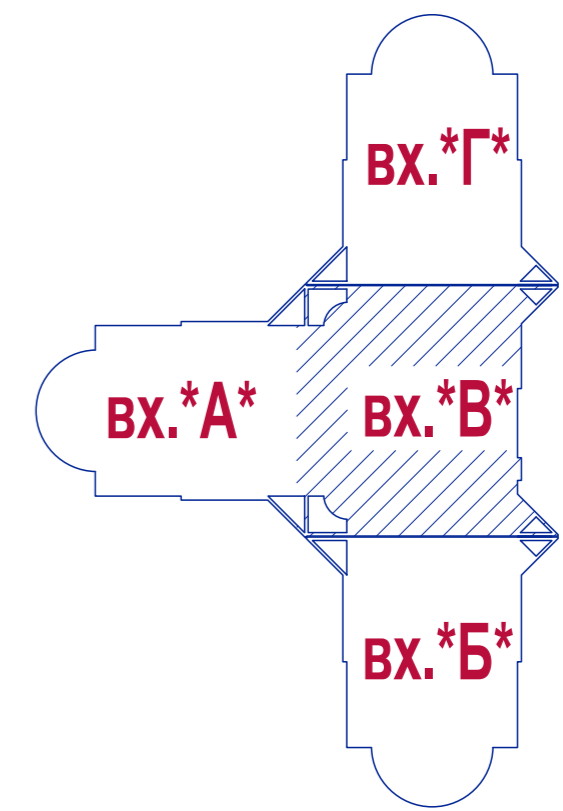
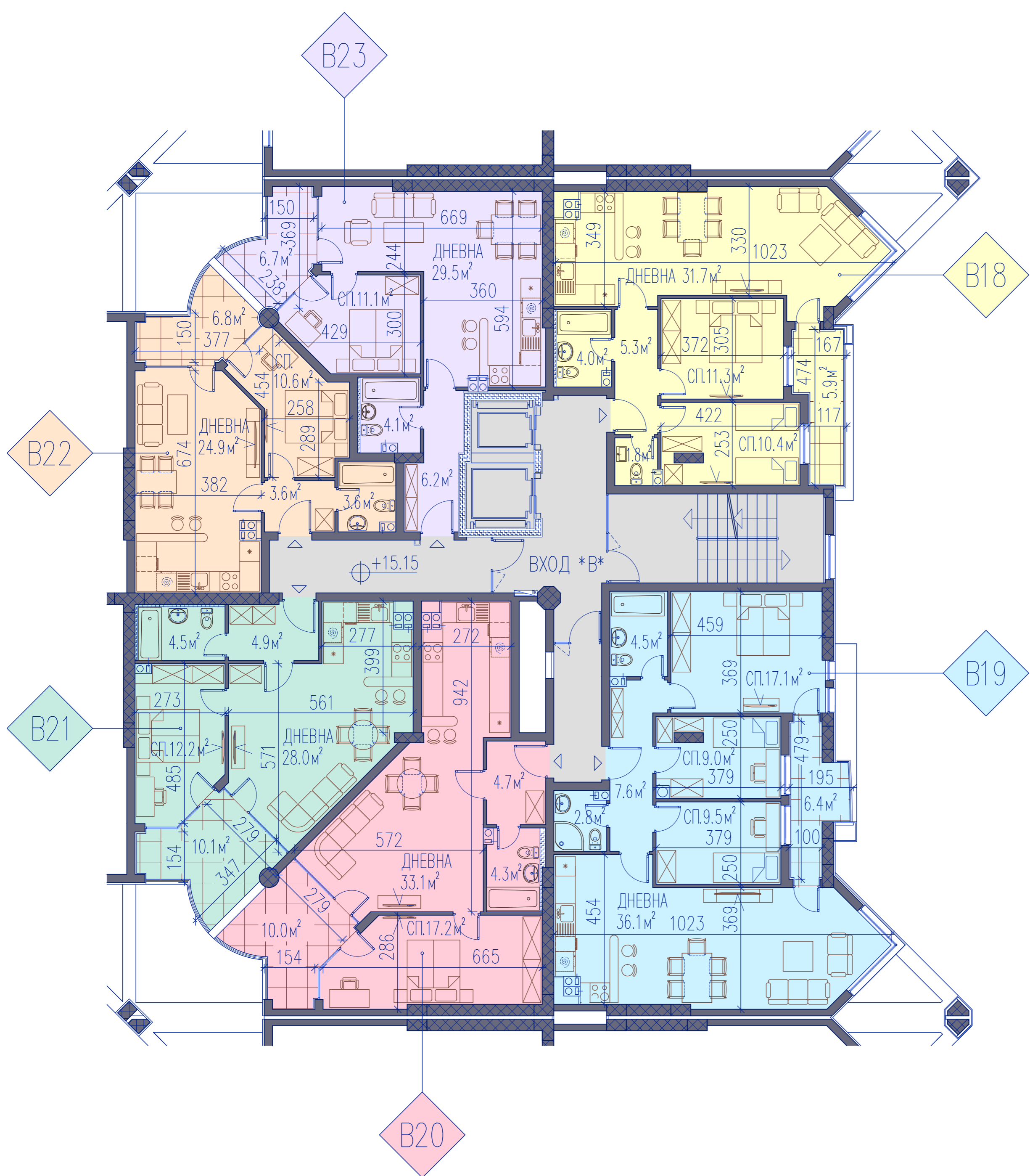

- Ап. В18 - 80,82кв.м /101,33/
- Ап. В19 - 107,53кв.м/134,20/
- Ап. В20 - 76,85кв.м /96,38/
- Ап. В21 - 66,64кв.м /83,66/
- Ап. В22 - 55,64кв.м /70,08/
- Ап. В23 - 65,00кв.м /81,59/

**ВХОД \*В\***  
РАЗПРЕДЕЛЕНИЕ ПЕТИ ЕТАЖ

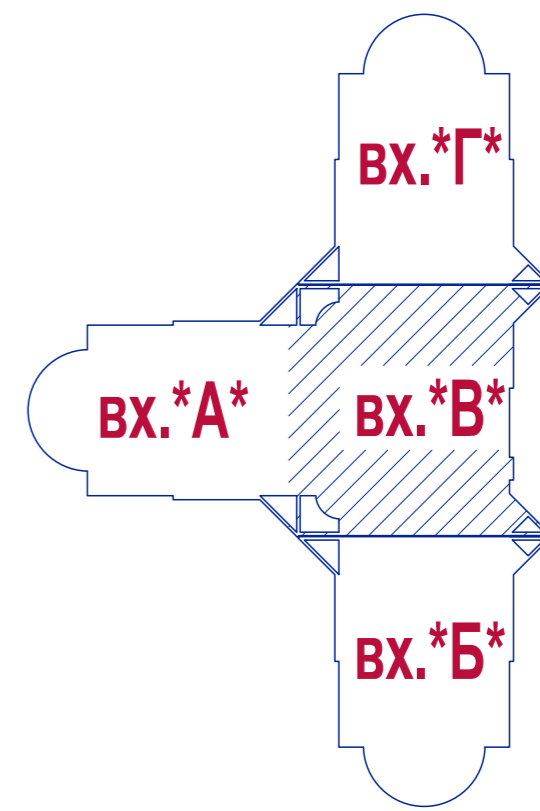

- Ап. В24 - 80,82кв.м /101,32/**
- Ап. В25 - 107,53кв.м/134,13/**
- Ап. В26 - 76,85кв.м /96,36/**
- Ап. В27 - 66,76кв.м /83,73/**
- Ап. В28 - 55,64кв.м /70,08/**
- Ап. В29 - 64,86кв.м /81,42/**

**ВХОД \*В\***  
РАЗПРЕДЕЛЕНИЕ ШЕСТИ ЕТАЖ

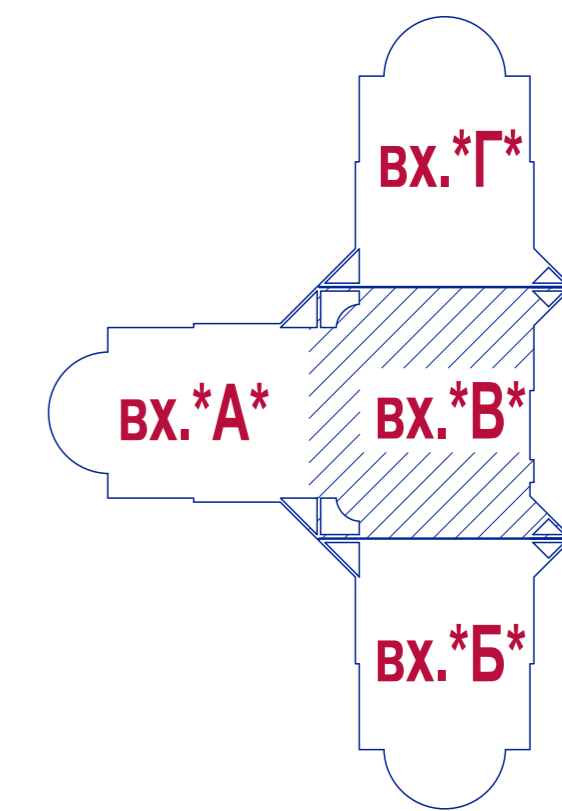
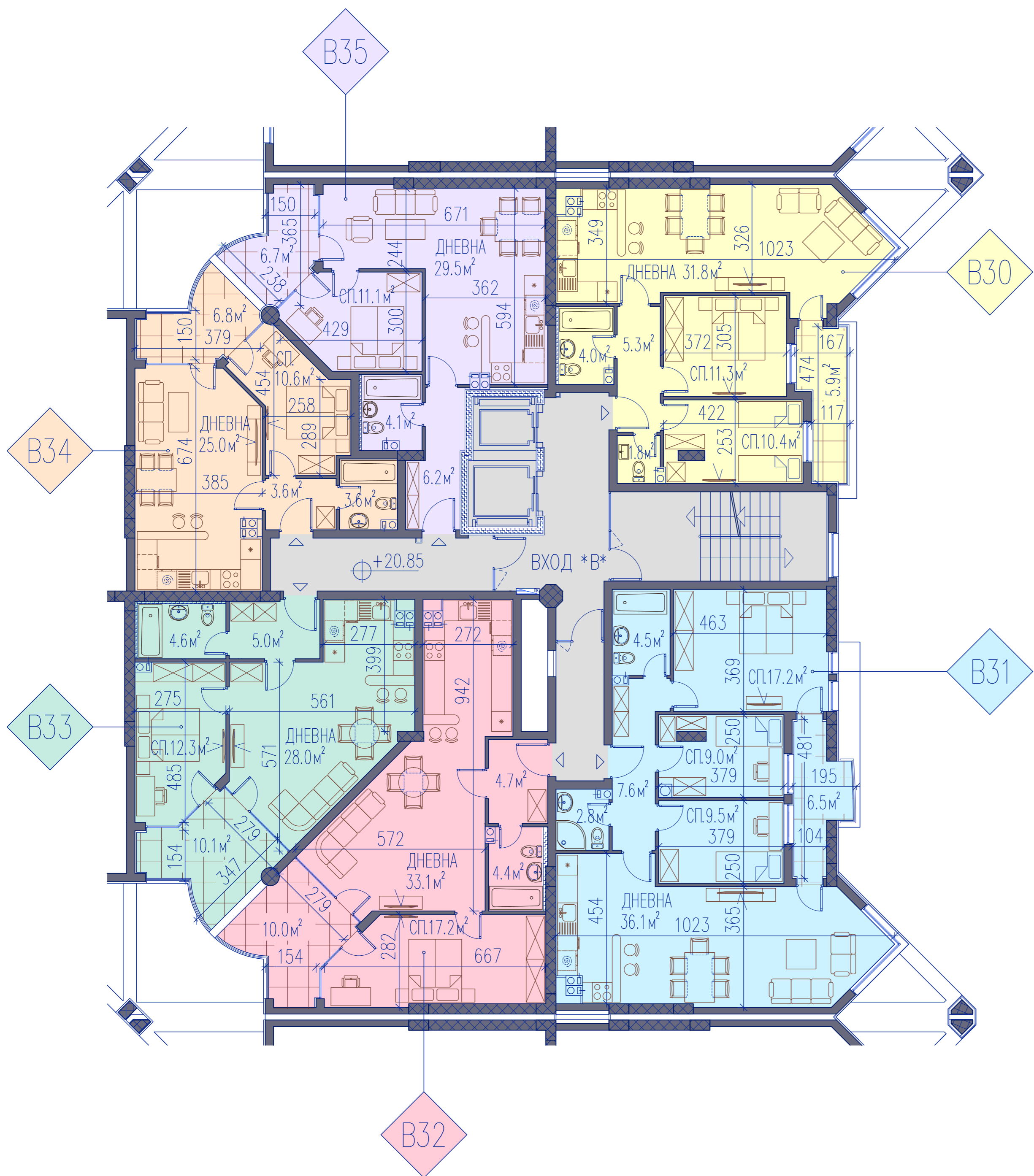

- Ап. В30 - 80,64кв.м /101,04/**
- Ап. В31 - 107,53кв.м /134,13/**
- Ап. В32 - 76,62кв.м /96,06/**
- Ап. В33 - 66,76кв.м /83,73/**
- Ап. В34 - 55,69кв.м /70,14/**
- Ап. В35 - 64,86кв.м /81,42/**

**ВХОД \*В\***  
**РАЗПРЕДЕЛЕНИЕ СЕДМИ ЕТАЖ**

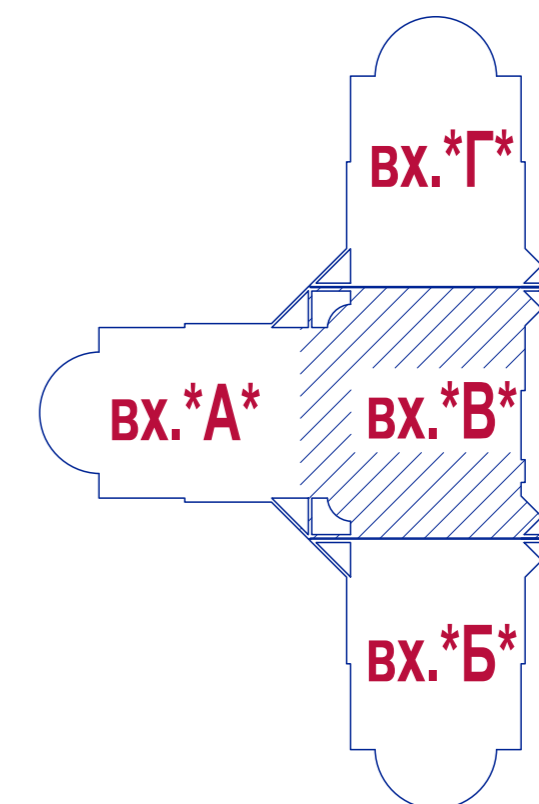
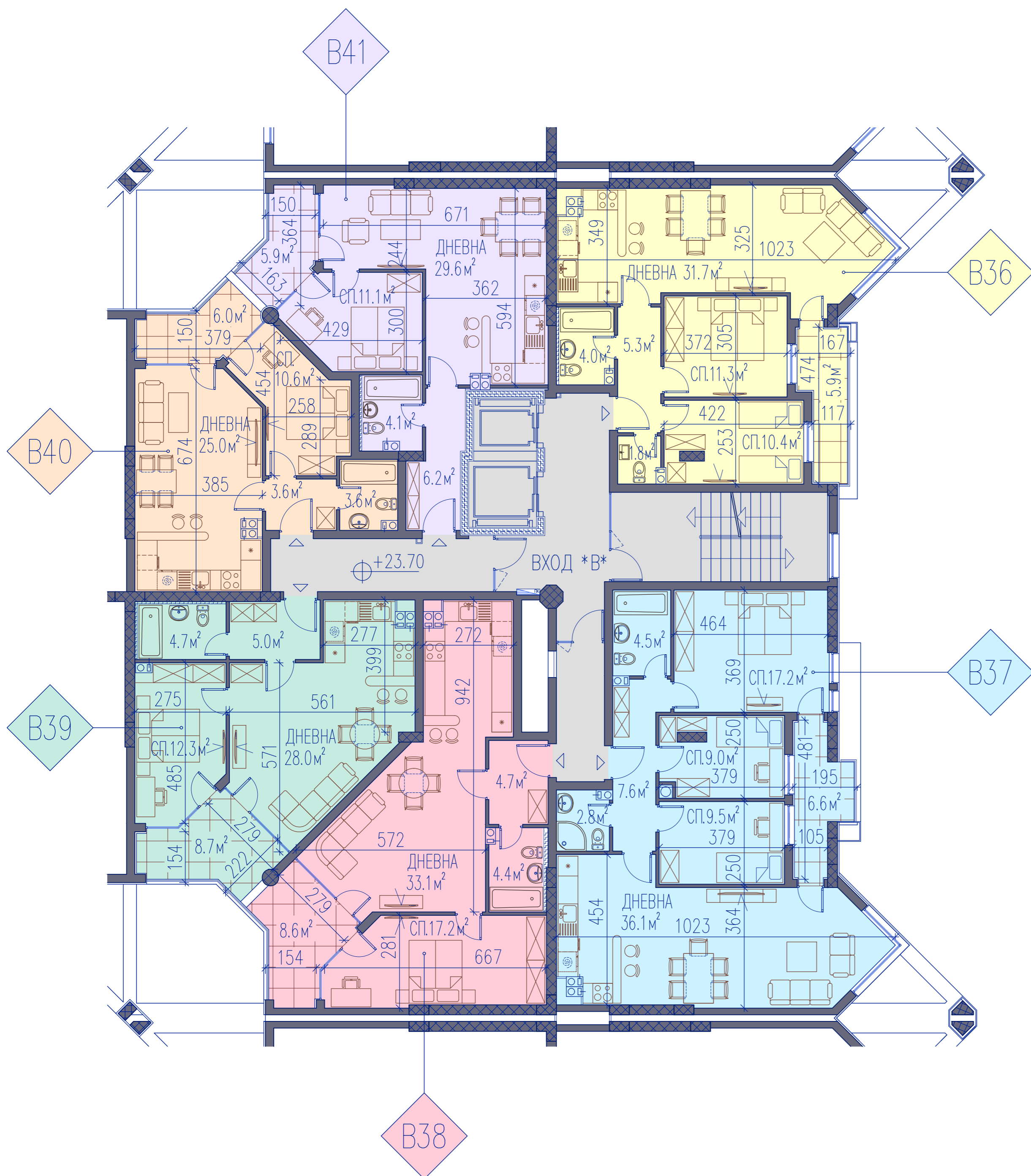

- Ап. В36 - 80,71кв.м /101,10/
- Ап. В37 - 106,40кв.м /132,61/
- Ап. В38 - 75,13кв.м /94,25/
- Ап. В39 - 65,41кв.м /82,09/
- Ап. В40 - 54,85кв.м /69,08/
- Ап. В41 - 64,03кв.м /80,41/

**ВХОД \*В\***  
РАЗПРЕДЕЛЕНИЕ ОСМИ ЕТАЖ

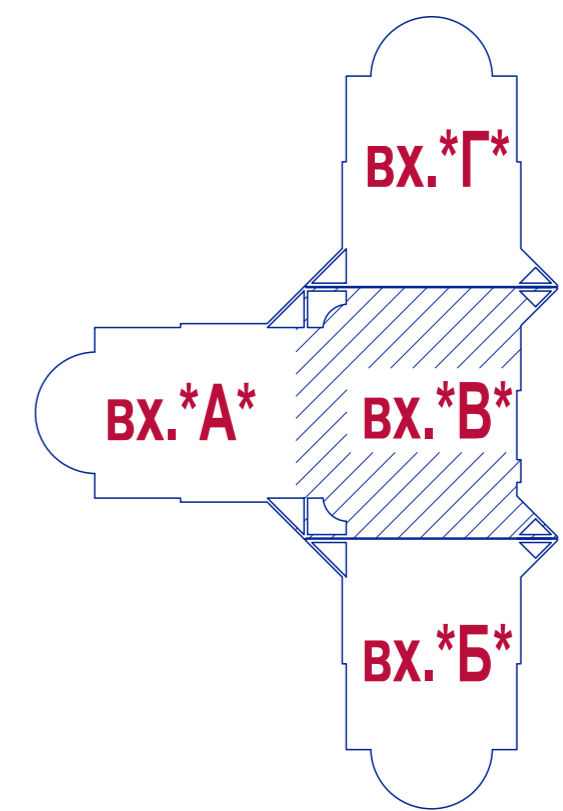
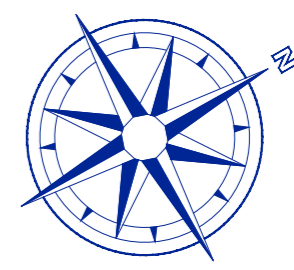

- Ап. В42 - 80,71кв.м /101,10/**
- Ап. В43 - 106,40кв.м /132,53/**
- Ап. В44 - 75,13кв.м /94,22/**
- Ап. В45 - 65,41кв.м /82,09/**
- Ап. В46 - 54,86кв.м /69,04/**
- Ап. В47 - 64,03кв.м /80,30/**

**ВХОД \*В\***  
**РАЗПРЕДЕЛЕНИЕ ДЕВЕТИ ЕТАЖ**

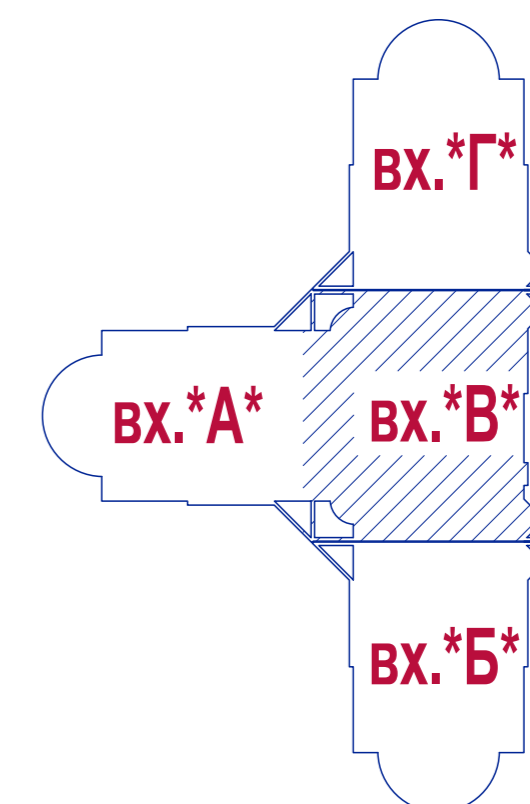
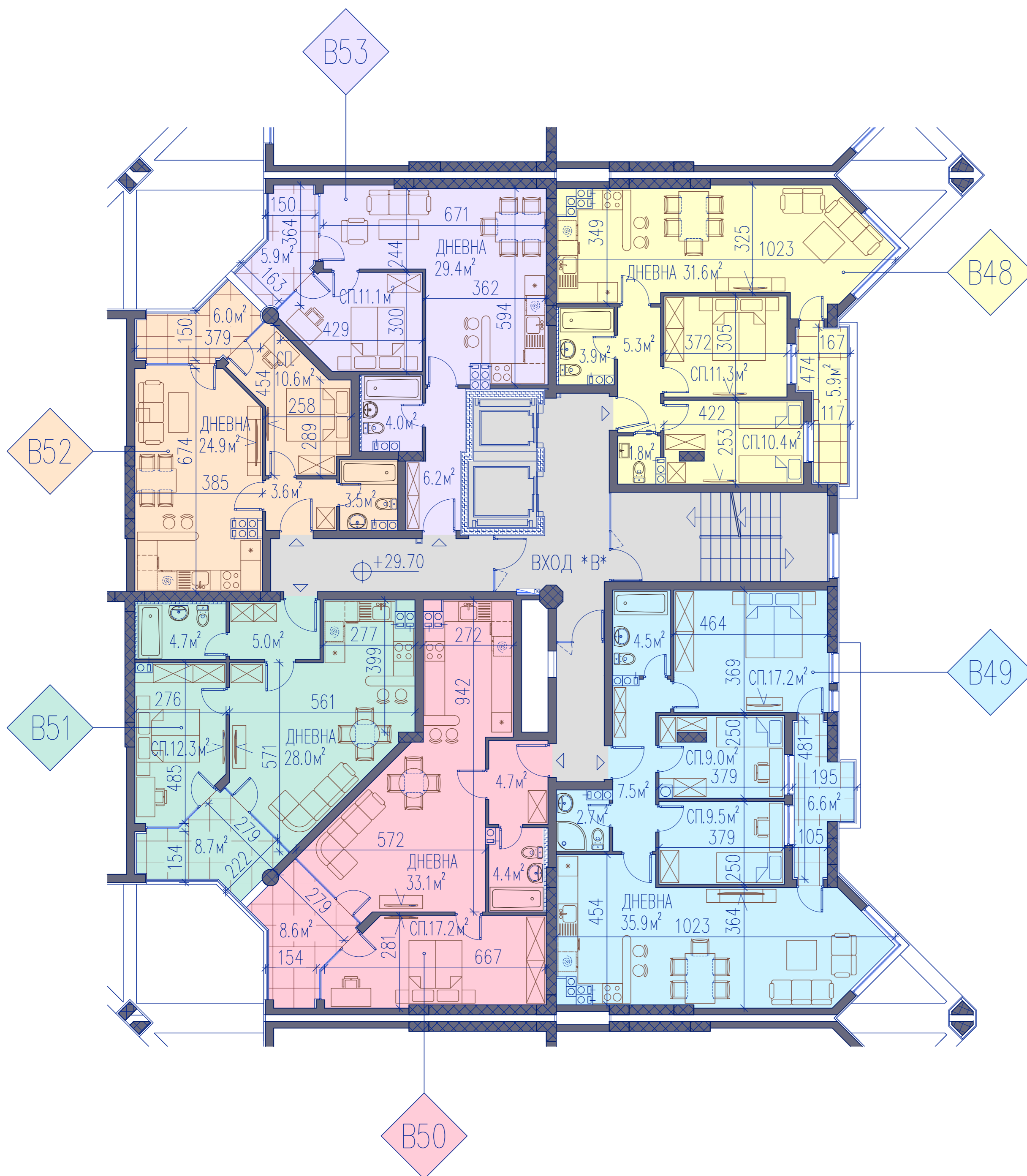

- Ап. В48 - 80,71кв.м /101,10/
- Ап. В49 - 106,40кв.м /132,51/
- Ап. В50 - 75,13кв.м /94,18/
- Ап. В51 - 65,41кв.м /82,09/
- Ап. В52 - 54,85кв.м /69,01/
- Ап. В53 - 64,03кв.м /80,30/

**ВХОД \*В\***  
РАЗПРЕДЕЛЕНИЕ ДЕСЕТИ ЕТАЖ



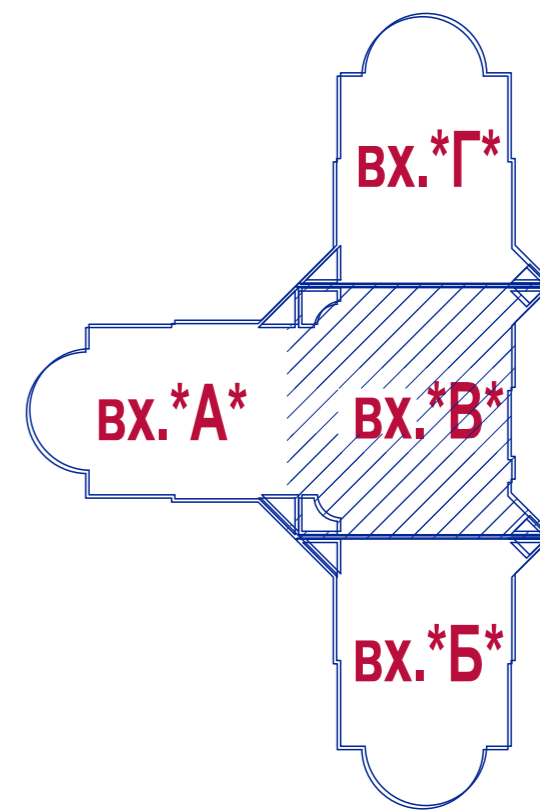
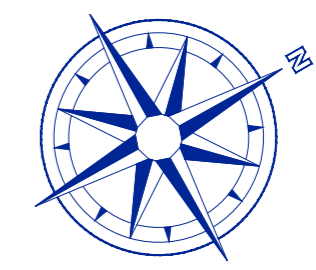
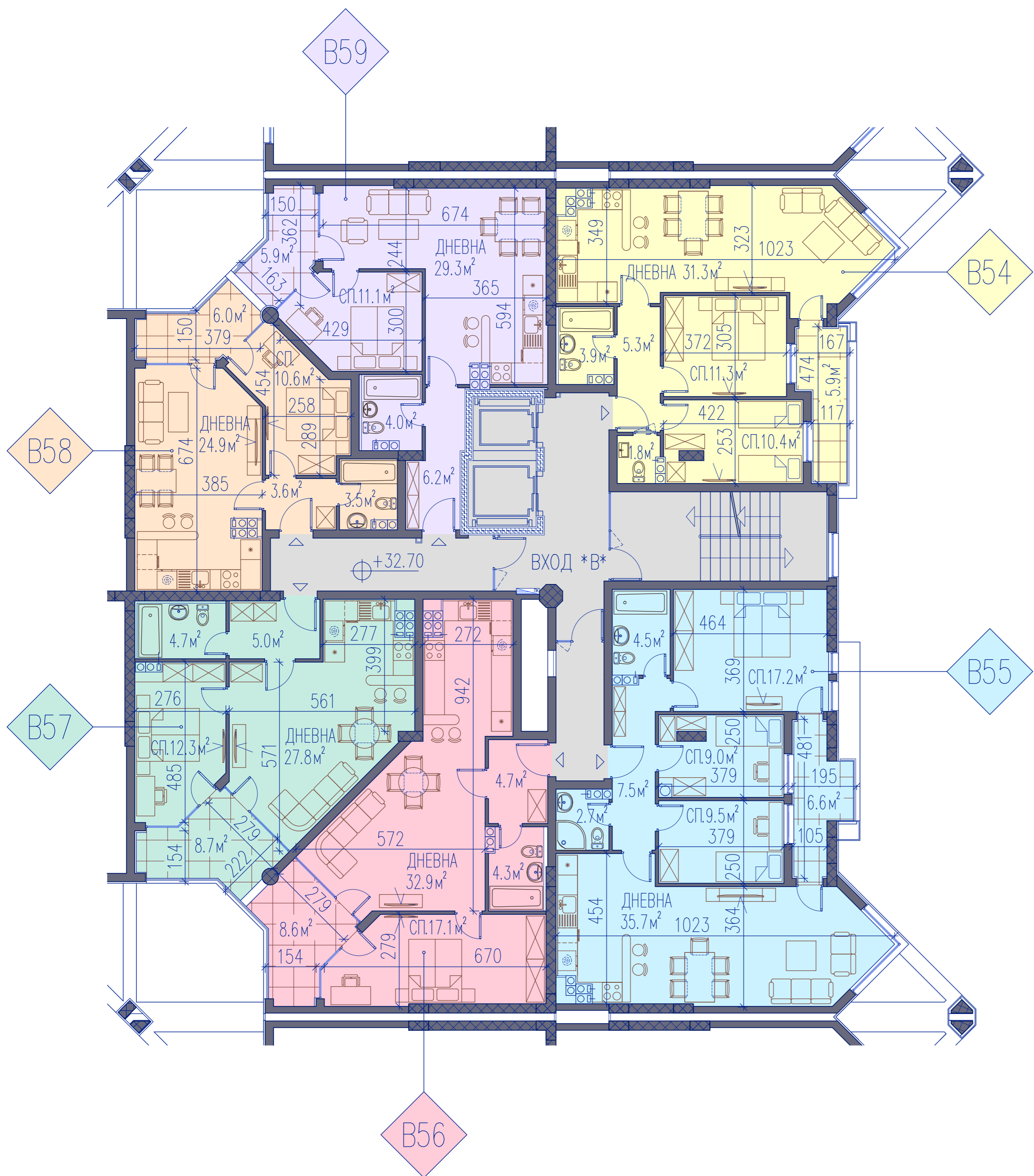

- Ап. В54 - 80,71кв.м /101,10/**
- Ап. В55 - 106,40кв.м /132,49/**
- Ап. В56 - 75,13кв.м /94,18/**
- Ап. В57 - 65,41кв.м /82,09/**
- Ап. В58 - 54,85кв.м /69,01/**
- Ап. В59 - 64,03кв.м /80,30/**

**ВХОД \*В\***  
**РАЗПРЕДЕЛЕНИЕ ЕДИНАДЕСЕТИ ЕТАЖ**

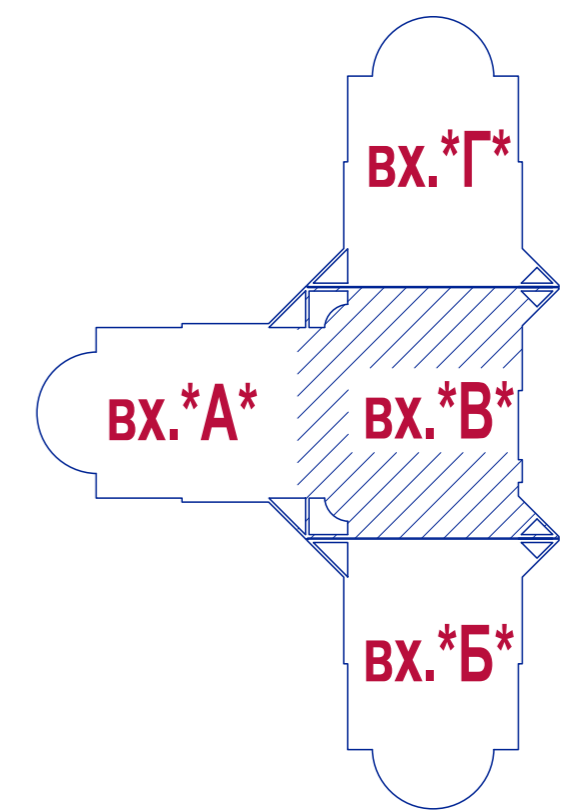
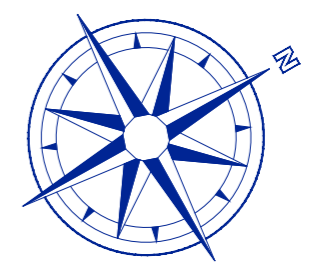
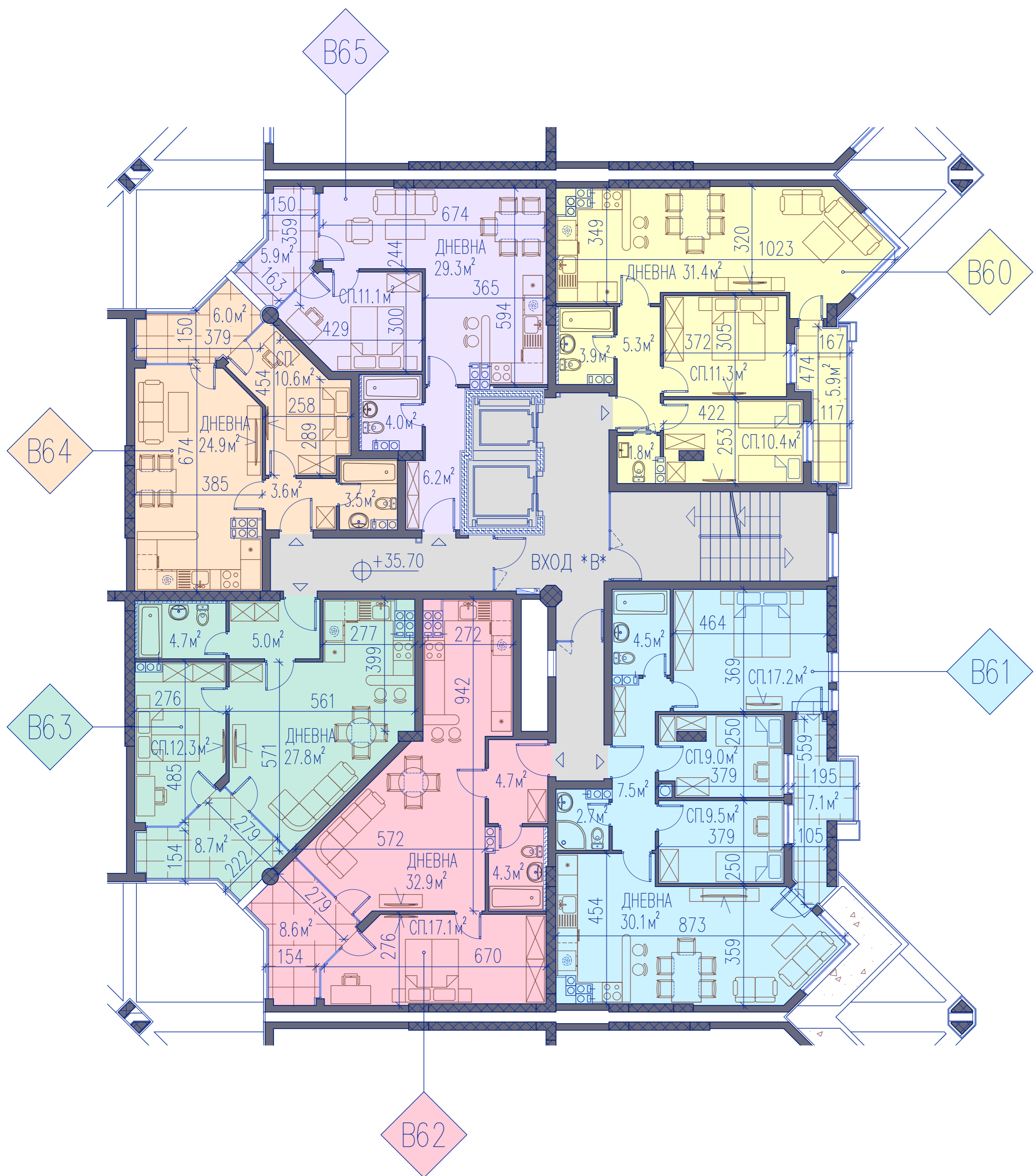

- Ап. В60 - 80,71кв.м /101,10/**
- Ап. В61 - 101,01кв.м /125,92/**
- Ап. В62 - 75,13кв.м /94,16/**
- Ап. В63 - 65,41кв.м /82,09/**
- Ап. В64 - 54,85кв.м /68,89/**
- Ап. В65 - 64,03кв.м /80,30/**

**ВХОД \*В\***  
**РАЗПРЕДЕЛЕНИЕ ДВНАДЕСЕТИ ЕТАЖ**